



# Maximo®

**DE** Aufbau- und Bedienungsanleitung

**GB** Instructions for assembly and use

**FR** Notice de montage et d'emploi

**IT** Istruzioni di montaggio ed uso

**ES** Instrucciones de montaje y de uso

**RUS** Инструкция по монтажу и эксплуатации

**CHN** 组装及使用说明



**1**

- Ergonomisch geformte Polster
- Ergonomically shaped upholstery
- Rembourrage ergonomique
- Imbottiture di forma ergonomica
- Acolchonados ergonómicos
- Эргономичная форма обивки
- 符合人体工程学的椅垫

**2**

- Stoffbezüge abnehmbar
- Upholstery can be removed
- Revêtements textiles amovibles
- Rivestimenti di stoffa rimovibili
- Telas desfundables
- Съёмные матерчатые чехлы
- 椅垫外罩可拆换

**3**

- 2 Geheimfächer
- 2 secret compartments
- 2 compartiments secrets
- 2 scomparti segreti
- 2 compartimentos secretos
- Потайные отсеки
- 2个暗盒

**4**

- Gebremste Universal-Rollen für weiche und harte Böden
- Combi casters
- Roulettes universelles avec freins
- Rotelle combinate
- Rodillos frenados para piso duro o blando
- Универсальные тормозные ролики для мягких и жестких покрытий пола
- 带制动的万用脚轮适合硬质和软质地板使用。

**5**

- Skala
- Scale
- Échelle
- Scala
- Escala
- Шкала
- 刻度尺

**6**

- Einfache Höhen- und Sitztiefeinstellung
- Simple height adjustment of seat and back rest
- Facilité du réglage en hauteur pour l'assise et le dossier
- Facile regolazione in altezza della sedia e dello schienale
- Ajuste fácil para la altura y la profundidad del asiento
- Простая регулировка сиденья по высоте и глубине
- 简易调整座高和座深

**7**

- Sicherer Stand
- Secure stand
- Stabilité à toute épreuve
- Sicuro posizionamento
- Postura segura
- Устойчивость
- 站立稳固

**8**

- Drehkranz feststellbar
- Foot base can be locked
- Couronne de pivotement verrouillable
- Corona girevole bloccabile
- Corona giratoria bloqueable
- Блокировка вращения основания
- 旋转脚座可固定



- Alles auspacken und Inhalt auf Vollständigkeit prüfen
- Unpack the contents and ensure nothing is missing
- Déballez tout et vérifiez que le contenu est bien complet
- Togliere la fornitura dall'imballo e accertarsi che non ci siano pezzi mancanti
- Desempaque todos los elementos y compruebe que no falta ninguno
- Все распаковать и проверить содержимое на комплектность
- 拆开所有包装并检查是否齐全

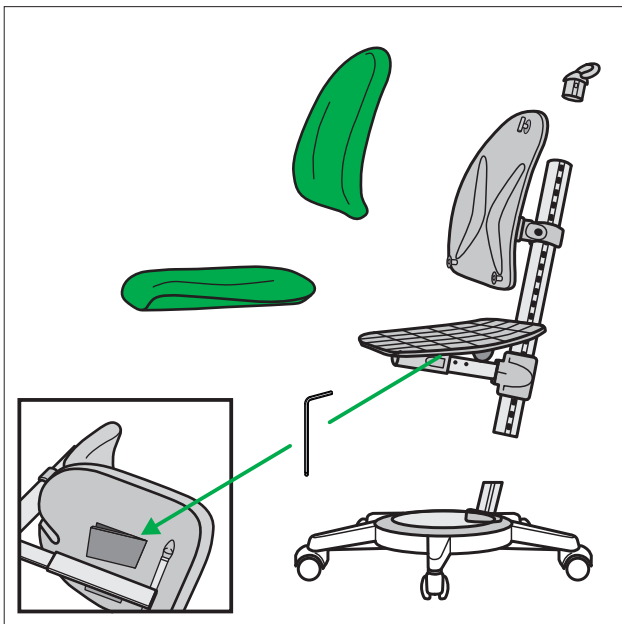

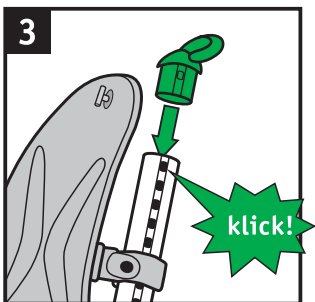
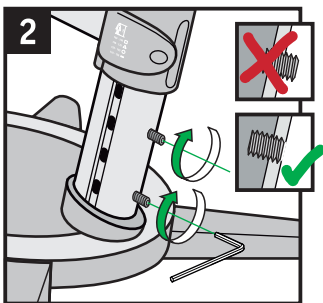
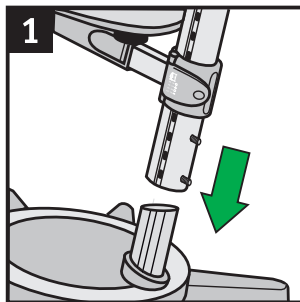
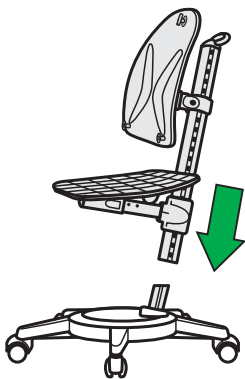

- Schrauben fest eindrehen, dabei hörbare Knack-Geräusche sind ohne Belang
- Insert the screws firmly; any creaking noises that may occur are of no significance.
- Fixer les vis franc en tournant. Les éventuels bruits de craquement émis sont sans importance.
- Avvitare le viti stringerle bene; gli eventuali scricchiolii che si potrebbero percepire sono irrilevanti.
- Apriete firme los tornillos, es irrelevante si mientras se escuchan sonidos chascados.
- Закрутите винты до конца—слышимые щелчки при этом не имеют значения.
- 拧紧螺丝，听到咔嗒声响无妨

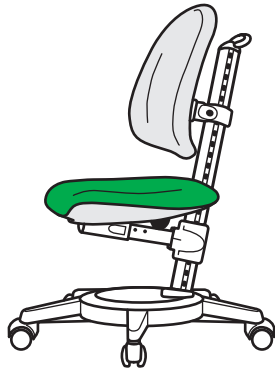
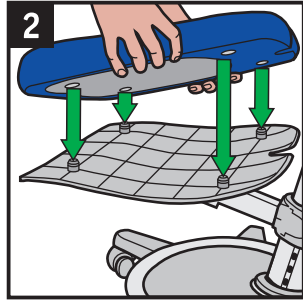
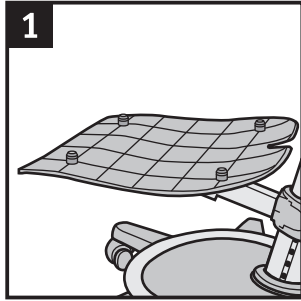
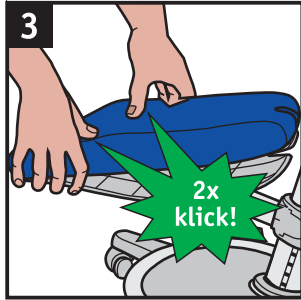

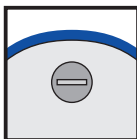
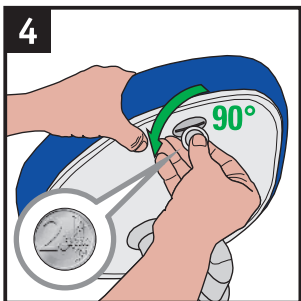
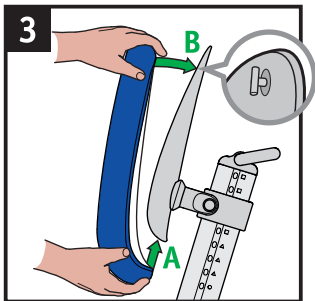
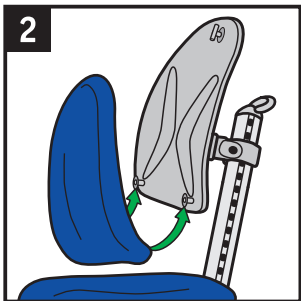
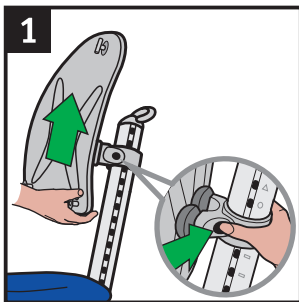
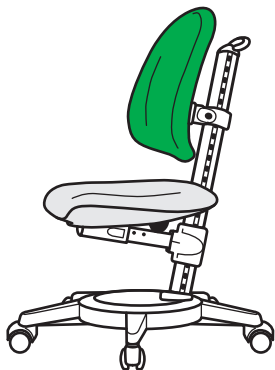

offen  
open  
ouvert  
aperto  
abierto  
открытые  
开着



geschlossen  
closed  
fermé  
chiuso  
cerrado  
закрытые  
已关闭

Montage der Rückenlehne  
Assembly of back  
Montage du dossier

Montaggio dello schienale  
Montaje del acolchonado del respaldo  
Монтаж спинки

靠背的组装

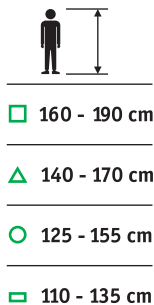
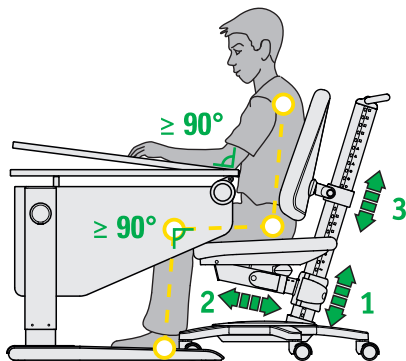

- Sitzhöhe (1) nach Körpergröße einstellen (Beinwinkelung  $\geq 90^\circ$ ). Sitztiefe (2) und Rückenlehne (3) nach Skala anpassen.
- Seat (1) adjust to suit body height (angle at knee  $90$  degrees). Seating depth (2) and Backrest set (3) using height scale.
- Régler la hauteur de l'assise (1) en fonction de la taille de l'utilisateur (angle des genoux  $\geq 90^\circ$ ). Régler l'approche (2) et le dossier (3) à l'échelle.
- (1) Regolazione altezza seduta (angolo gamba  $90^\circ$ ). (2) Profondità sedile. (3) Schienale regolabile con forature a scatto.
- Ajustar la altura del asiento (1) (ángulo de la rodilla  $\geq 90^\circ$ ). Adaptar la profundidad (2) y el respaldo (3) por medio de la escala.
- Подогнать высоту сиденья (1) по росту (угол сгибания в коленях  $\geq 90^\circ$ ). Установить глубину сиденья (2) и положение спинки (3) по шкале.
- 根据身高调整座高(1) (腿弯曲角度  $\geq 90$ 度)。通过刻度尺调整座深(2)和靠背(3)。



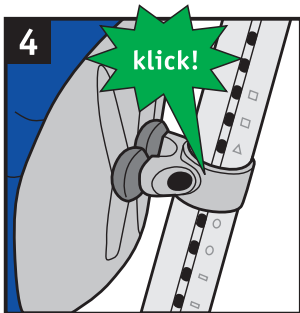
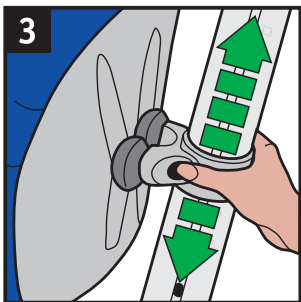
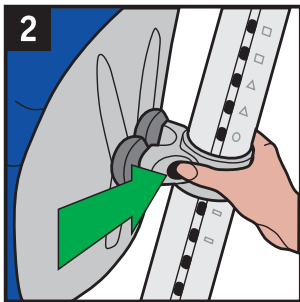
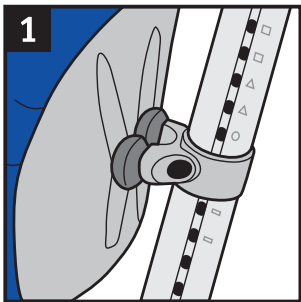
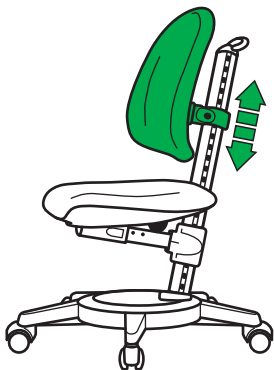

靠背的调高

Regolazione altezza schienale  
Ajuste de la altura del respaldo  
Регулировка высоты спинки

Höhenverstellung der Rückentlehne  
Height adjustment of the back  
Réglage en hauteur du dossier

Höhenverstellung der Sitzfläche  
Height adjustment of the seat  
Réglage en hauteur de l'assise

Regolazione altezza seduta  
Ajuste de la altura del asiento  
Регулировка сиденья по высоте

椅面的调高

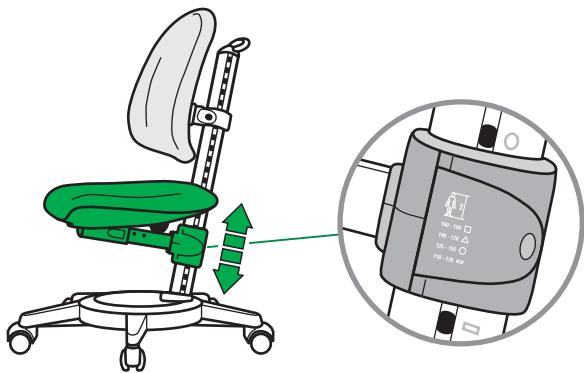
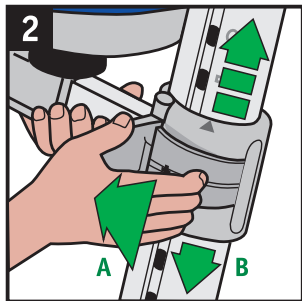
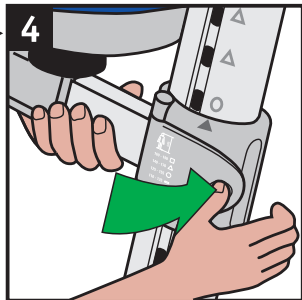
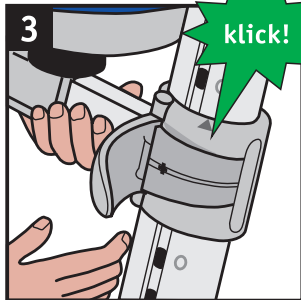

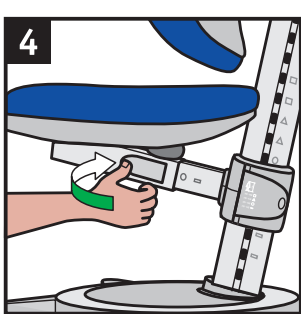
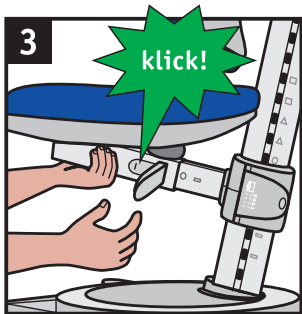
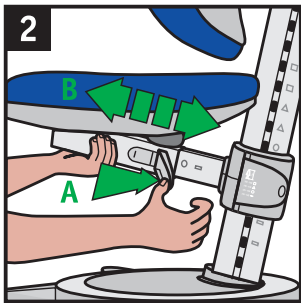
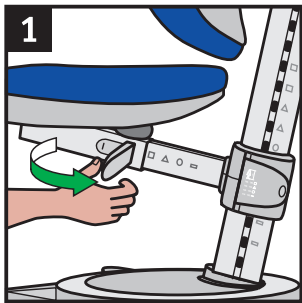
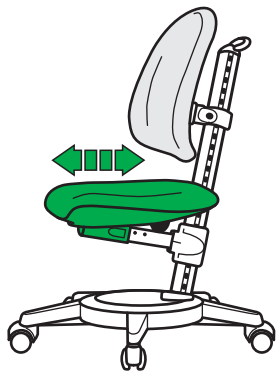

Tiefenverstellung der Sitzfläche  
Depth adjustment of the seat  
Réglage en profondeur de l'assise

Regolazione profondità' seduta  
Ajuste de la profundidad del asiento  
Регулировка глубины сиденья

椅面的调深

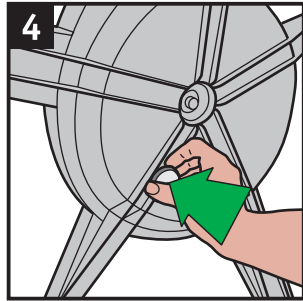
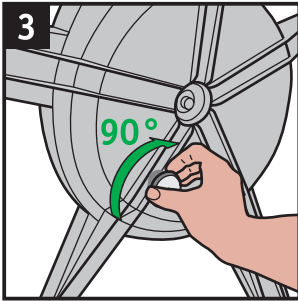
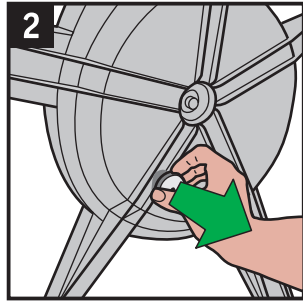
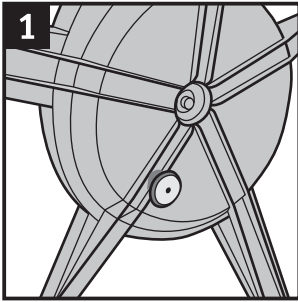

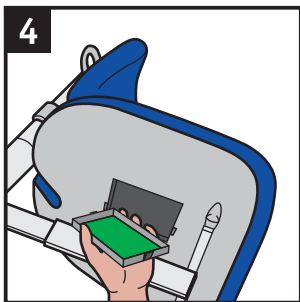
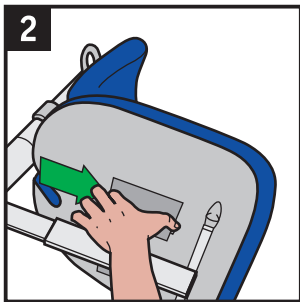
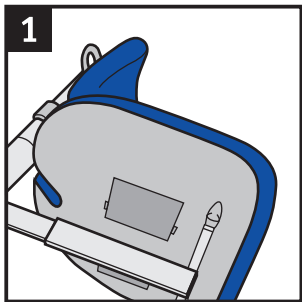
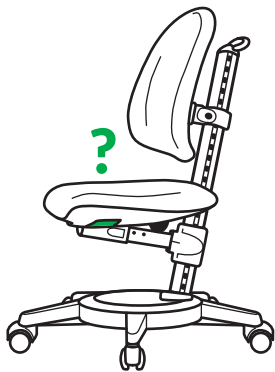

暗盒

Scompartimento segreto  
Compartimentos secretos  
Потайные отсеки

Die Geheimfächer  
Secret compartments  
Compartments secrets

Überziehen des Rückenpolsters  
Covering back cushion  
Pose du revêtement du dossier

Rivestimento dello schienale  
Recubrir el acolchonado del respaldo  
Надевание чехла спинки

套上靠背  
垫的外罩

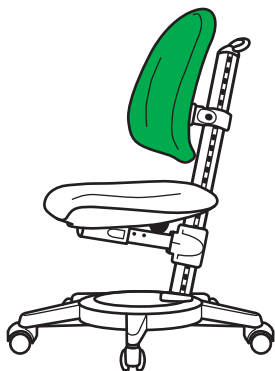
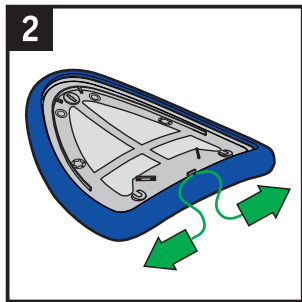
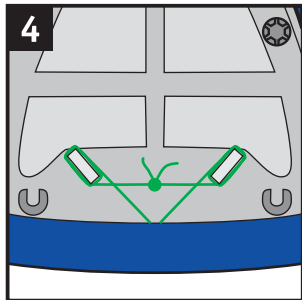
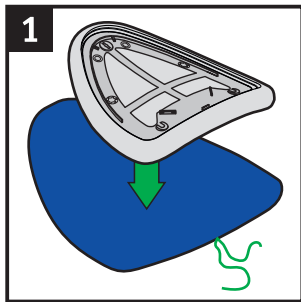
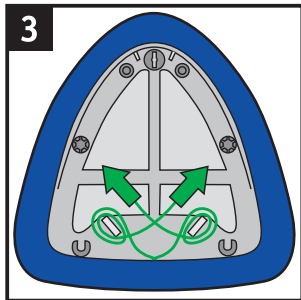

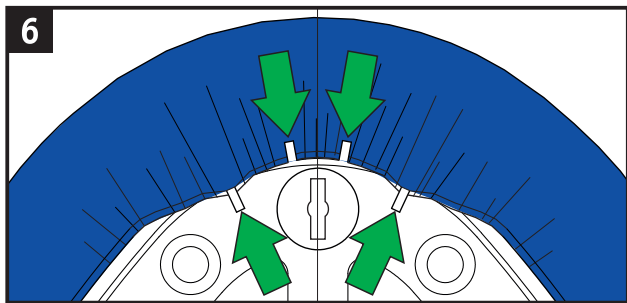
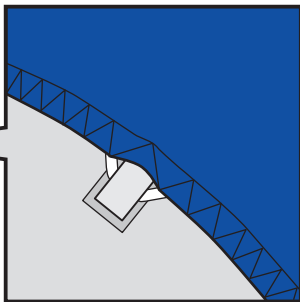

套上靠背  
垫的外罩

Rivestimento dello schienale  
Recubrir el acolchonado del respaldo  
Надевание чехла спинки

Überziehen des Rückenpolsters  
Covering back cushion  
Pose du revêtement du dossier

Abnehmen der Bezüge zur Reinigung  
 Removing the fabrics for washing  
 Déhousseage des tissus pour nettoyage

Amovibilita' del tessuto per il lavaggio  
 Quitar la tela para el lavado  
 Снятие чехлов для чистки

拆洗外罩

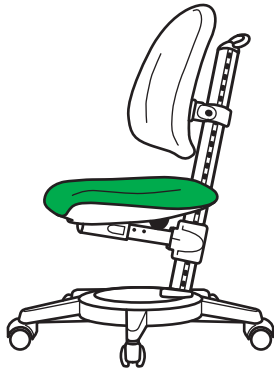
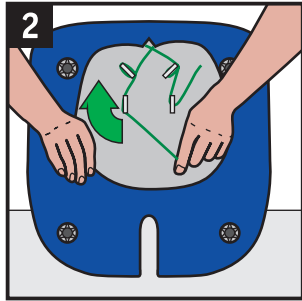
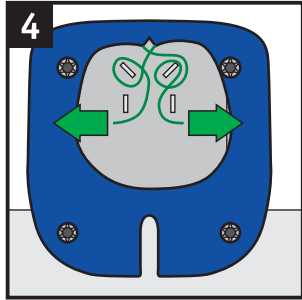
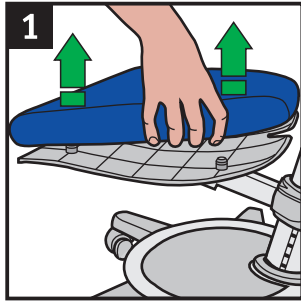
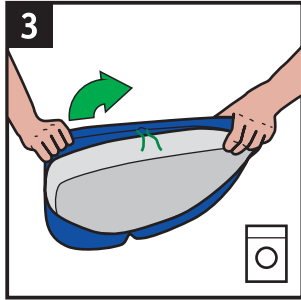



- 
- **Stuhlbezüge**  
Pflegehinweise siehe Etikett
  - **Fabrics**  
Care instructions see label
  - **Tissus**  
Instructions d'entretien voir étiquette
  - **Tessuti**  
Istruzioni per la cura vedi etichetta
  - **Tela**  
Instrucciones de cuidado ver en la etiqueta
  - **Чехлы стула**  
Инструкции по уходу см. на этикетке
  - **座椅外罩**  
清洗说明见标签



- Maximo - Gleiter:**  
 Die Rollen können gegen Gleiter ausgetauscht werden.  
 Aus schwarzem Kunststoff mit stabilem Stahlstift.
- Maximo - glides:**  
 The casters can be exchanged for glides.  
 In black plastic with sturdy steel pin.
- Maximo - patins:**  
 A embouter en remplacement des roulettes. En matière synthétique noire avec tige d'acier robuste.
- Maximo - scorrevoli:**  
 Da inserire al posto delle rotelle. In materiale sintetico nero con robusto perno d'acciaio.
- Maximo - tapas:**  
 Los rodillos pueden cambiarse por tapas de plástico negro con una clavija de acero.
- Maximo - скользящие опоры:**  
 Вставляются взамен роликов, из черной пластмассы с прочным стальным штифтом.
- Maximo - 滑件:**  
 可用滑件替代脚轮。由黑色合成材料制成，带坚固的钢钉。

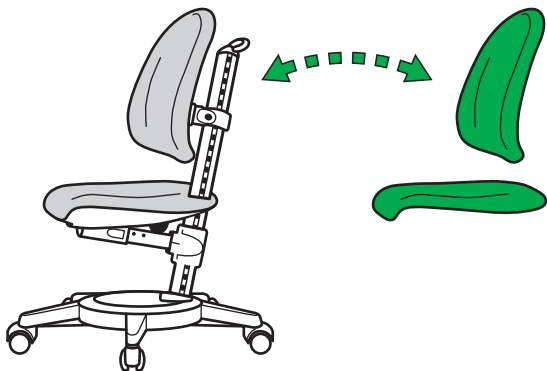

- **Polsterbezüge zum Wechseln:**

Bezüge in diversen Farben und Motiven finden Sie im aktuellen moll-Katalog. Fragen Sie Ihren moll-Fachhändler.

- **Upholstery can be removed for replacing:**

You can find fabrics in various colours and patterns in the current moll catalogue. Please ask your authorized moll-dealer.

- **Revêtements remplaçables:**

Vous trouverez les couleurs et motifs dans le catalogue moll. Veuillez contacter votre revendeur local moll.

- **Rivestimenti di stoffa rimovibili per la sostituzione:**

Tessuti e campionari sono visionabili all'interno del nuovo catalogo moll. Rivolgetevi al rivenditore autorizzato più vicino.

- **Fundas para cambiar:**

Fundas de colores y motivos diferentes se encuentran en el actual catálogo moll. Consulta su vendedor moll autorizado.

- **Чехлы для замены:**

Чехлы различных цветов и мотивов Вы найдете в актуальном каталоге фирмы moll. Обратитесь к местному дилеру фирмы moll.

- **备用椅垫外罩:**

各种不同颜色和图案的外罩请查阅最新moll产品目录。请联系您的moll专业经销商。

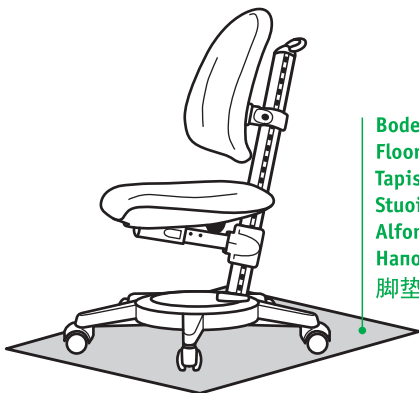

**Bodenmatte**  
**Floor mat**  
**Tapis**  
**Stuoia per pavimenti**  
**Alfombra protectora**  
**Напольный коврик**  
**脚垫**

- Info:**  
 In unbelastetem Zustand drehen sich die Rollen nicht und können Kratzspuren auf Laminat- und Parkettfußböden hinterlassen.
- Information:**  
 The castors will not turn if the chair is not loaded and they might leave marks or scratches on laminate or parquet floors.
- Infos:**  
 Lorsque le siège n'est pas occupé, les roulettes ne tournent pas et peuvent laisser des traces d'éraflures sur les sols en parquet et stratifié.
- Informazioni:**  
 In stato senza peso le rotelle non si girano e possono lasciare graffiature su laminato o pavimento di parquet.
- Información:**  
 Sin peso, las ruedas de la silla no giran, y pueden dejar huellas o rasguños en los suelos de laminado o de parquet.
- Информация:**  
 в состоянии без нагрузки ролики стула не вращаются и могут оставить царапины на ламинатных полах и паркете.
- 信息**  
 未坐人情况下脚轮不转动，因而复合或木质地板可能出现划痕。

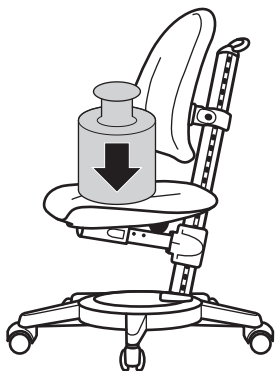

- **Maximale Belastung: 80 kg**
- **Maximum load: 80 kg**
- **Charge maximale: 80 kg**
- **Carico massimo: 80 kg**
- **Peso máximo: 80 kg**
- **Максимально допустимая нагрузка составляет 80 кг**
- **最大載重80公斤**

Panoramica sui pezzi di ricambio  
Resumen de piezas de recambio  
Ведомость запасных частей

备件清单

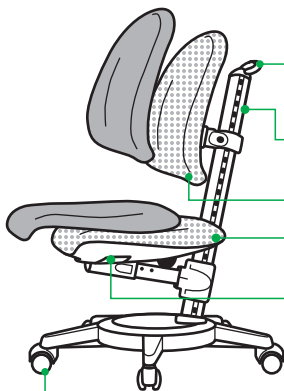

103 505

- |         |          |            |
|---------|----------|------------|
| 103 703 | grau     | grey       |
| 103 203 | hellgrau | light grey |
| 103 121 | weiß     | white      |
| 103 825 | silber   | silver     |

- |         |  |  |
|---------|--|--|
| 103 109 |  |  |
| 103 508 |  |  |

- |         |          |            |
|---------|----------|------------|
| 103 707 | grau     | grey       |
| 103 207 | hellgrau | light grey |

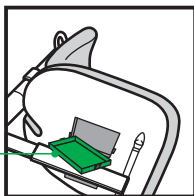

Ersatzteilübersicht  
Overview of spare parts  
Vue d'ensemble des pièces de rechange

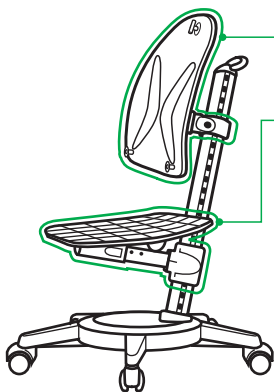

- |         |          |            |
|---------|----------|------------|
| 103 702 | grau     | grey       |
| 103 202 | hellgrau | light grey |

- |         |          |            |
|---------|----------|------------|
| 103 734 | grau     | grey       |
| 103 234 | hellgrau | light grey |

- |         |          |            |
|---------|----------|------------|
| 103 710 | grau     | grey       |
| 103 210 | hellgrau | light grey |

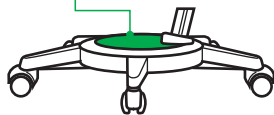

- |         |          |            |
|---------|----------|------------|
| 103 715 | grau     | grey       |
| 103 215 | hellgrau | light grey |

- Bitte bewahren Sie diese Montageanleitung auf!
- Please carefully keep these assembly instructions
- Merci de conserver cette notice de montage!
- Si prega di conservare sempre le presenti istruzioni per il montaggio!
- Por favor, guarde estas instrucciones de montaje.
- Пожалуйста, храните данную инструкцию по монтажу
- 请妥善保存本组装说明!  
服务地址 [service@moll-funktion.de](mailto:service@moll-funktion.de)



### Geprüfte Sicherheit

Certified safety

Sécurité certifiée

Certificato di sicurezza

Certificado de seguridad

Сертификат безопасности

安全性认证

### 5 Jahre Qualitäts-Garantie \*

5 year quality warranty \*

Qualité garantie 5 ans \*

5 anni di garanzia sulla qualità \*

5 años garantía de calidad \*

5-летняя гарантия качества \*

5年质量保证\*



- \* Laut unserer Garantien
- \* According to our warranties
- \* Voir nos garanties
- \* Come da nostra garanzia
- \* Como da nuestra garantía
- \* В соответствии с нашими гарантийными обязательствами
- \* 根据我方质保说明

**moll Funktionsmöbel GmbH**  
Rechbergstraße 7  
D-73344 Gruibingen  
[service@moll-funktion.de](mailto:service@moll-funktion.de)

[www.moll-funktion.de](http://www.moll-funktion.de)